

**REKEYING KIT
INSTRUCTION MANUAL**



Before rekeying a lock, please read this instructions carefully and retain it for future reference.

TABLE OF CONTENTS

■ 1.0 Rekeying Kit Components.....	2
■ 2.0 Lockset Components	
2.1 Tubular Lock Parts.....	3
2.2 Cylindrical Lock Parts.....	4
2.3 Deadbolt Lock Parts.....	5-6
■ 3.0 Lockset Disassembly, Rekeying, Assembly	
3.1 Tubular Lock.....	7-17
3.2 Cylindrical Lock.....	18
3.3 Deadbolt Lock.....	19-24
■ 4.0 Principle of Pin Tumbler Mechanism	25-27
■ 5.0 Keying Device	
Keyed Different.....	28
Master Keyed	28-30
Construction Keyed.....	30-33
Master Construction Keyed.....	33-34
Keyed Alike.....	35

LOCKSET COMPONENTS

2.2 Cylindrical Lock Parts

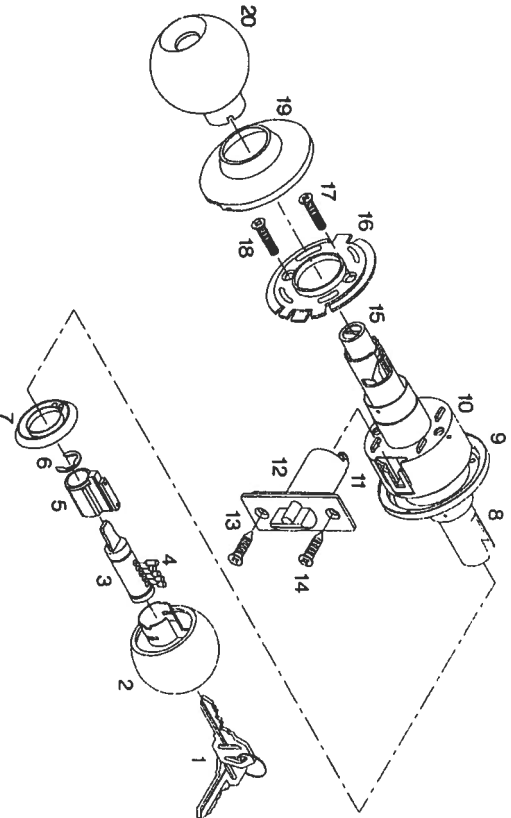

- (1) Key
- (2) Outside Knob
- (3) Plug
- (4) Bottom Pin
- (5) Cylinder Shell
- (6) Circlip
- (7) Rear Cap
- (8) Rollback
- (9) Outside Rose
- (10) Cylindrical Case

- (11) Retractor
- (12) Latch
- (13) Wood Screw
- (14) Wood Screw
- (15) Inside Push Button
- (16) Liner
- (17) Installation Screw
- (18) Installation Screw
- (19) Inside Rose
- (20) Inside Knob

LOCKSET COMPONENTS

2.3 Deadbolt Lock Parts

a. Single Cylinder Deadbolt

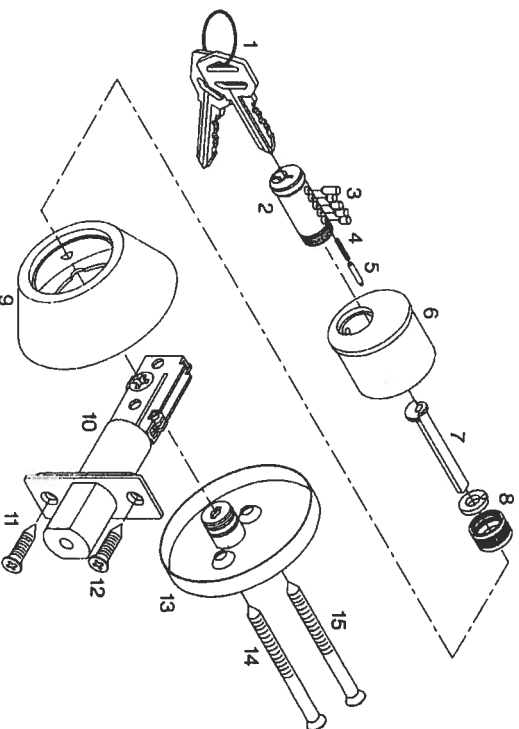

- (1) Key
- (2) Plug
- (3) Bottom Pin
- (4) Retaining Spring
- (5) Retaining Pin
- (6) Cylinder Housing
- (7) Tail Piece
- (8) Locking Nut

- (9) Outside Cylinder Guard
- (10) Wood Screw
- (11) Wood Screw
- (12) Wood Screw
- (13) Inside Rose
- (14) Installation Screw
- (15) Installation Screw

LOCKSET COMPONENTS

b. Double Cylinder Deadbolt

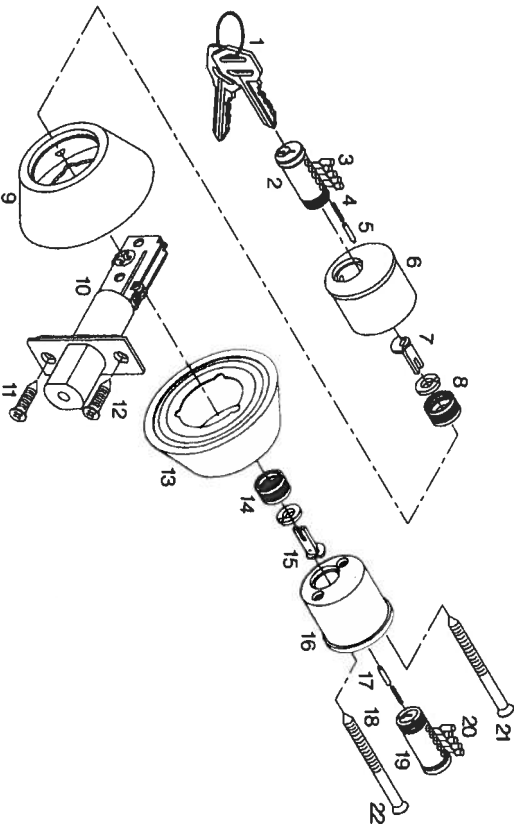

- (1) Key
- (2) Plug
- (3) Bottom Pin
- (4) Retaining Spring
- (5) Retaining Pin
- (6) Outside Cylinder Housing
- (7) Tail Piece
- (8) Locking Nut
- (9) Outside Cylinder Guard
- (10) Latch
- (11) Wood Screw
- (12) Wood Screw
- (13) Inside Cylinder Guard
- (14) Locking Nut
- (15) Tail Piece
- (16) Inside Cylinder Housing
- (17) Retaining Pin
- (18) Retaining Spring
- (19) plug
- (20) Bottom Pin
- (21) Installation Screw
- (22) Installation Screw

LOCKSET DISASSEMBLY, REKEYING, ASSEMBLY

3.1 Tubular Lock Keying

1. Insert key

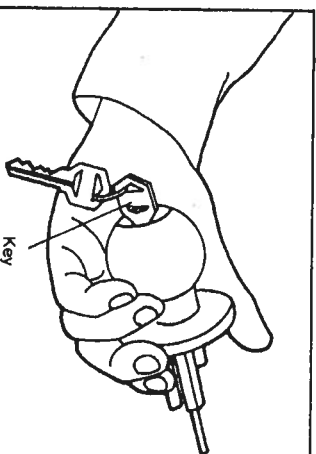

2. Turn outside knob clockwise until the knob catch aligns and is visible under the hole.

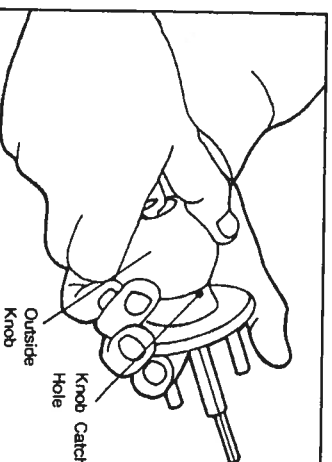

3. Use knob catch tool to depress knob catch for release of outside knob.

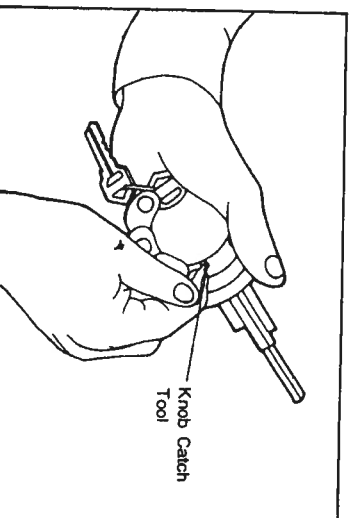

LOCKSET DISASSEMBLY, REKEYING, ASSEMBLY

4. Pull out outside knob.

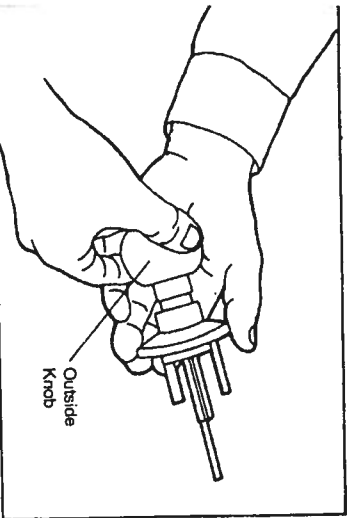

5. Aim the 2 prongs of the spanner tool at dimples (concave points) on rear cap.

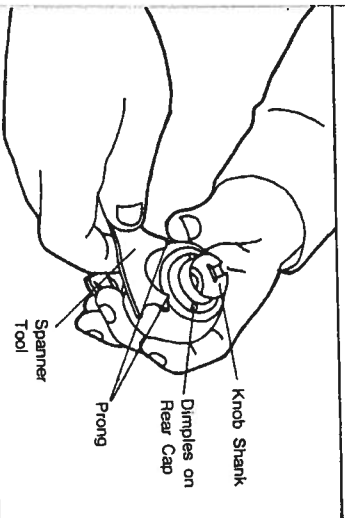

6. Turn spanner tool and cap clockwise until the indentation (dimple) on neck of knob shank falls into slot of knob shank.

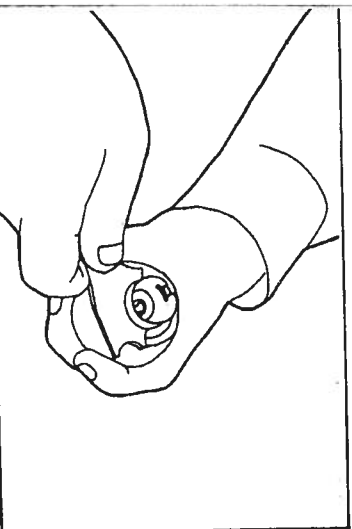

8

LOCKSET DISASSEMBLY, REKEYING, ASSEMBLY

7. Pull out rear cap by using long nose pliers. Turn knob left and right to free cap.

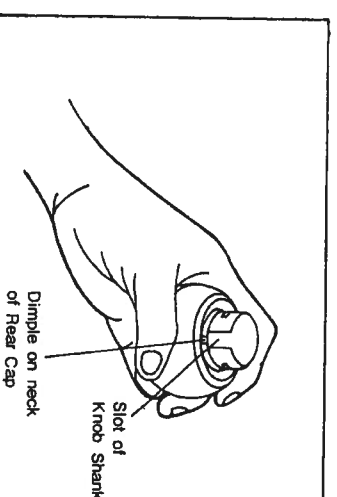
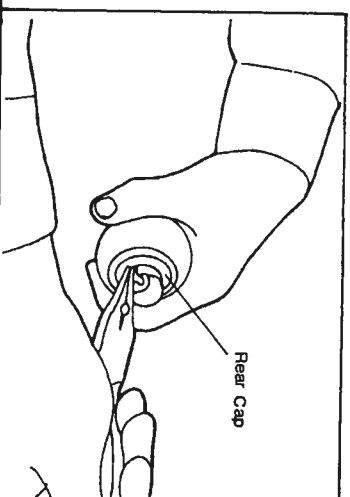

9

LOCKSET DISASSEMBLY, REKEYING, ASSEMBLY

8. Remove end cap on plug.

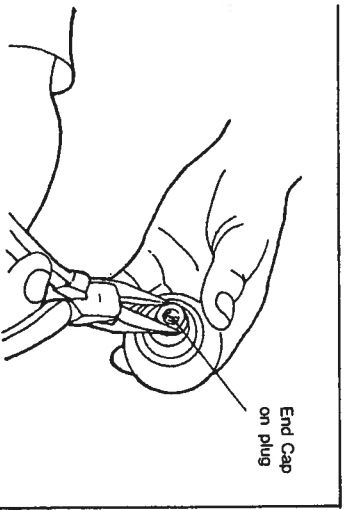

9. Using long nose pliers to hold the plug. Pull out the key and then remove the cylinder plug assembly. (Note: Do not pull out the key before holding the plug with pliers to avoid dropping the plug)

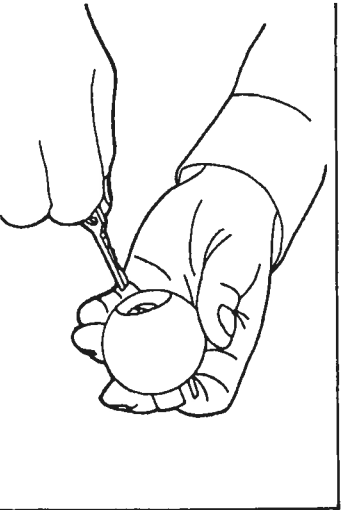

10. Insert key again into the plug.

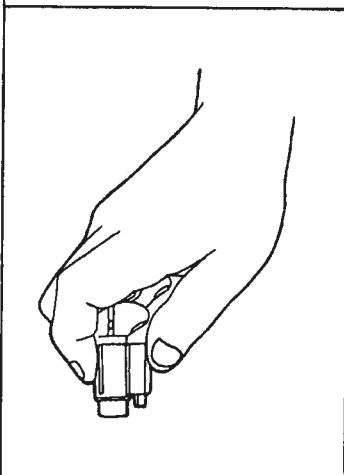

11. Use end of spanner tool to push out circlip.

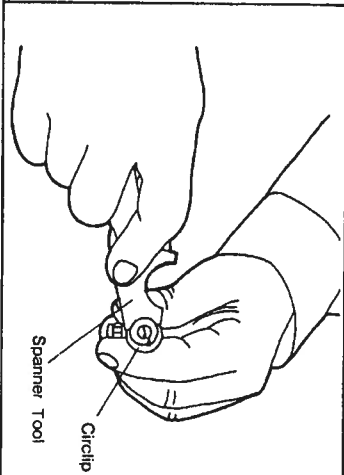

12. Remove circlip.

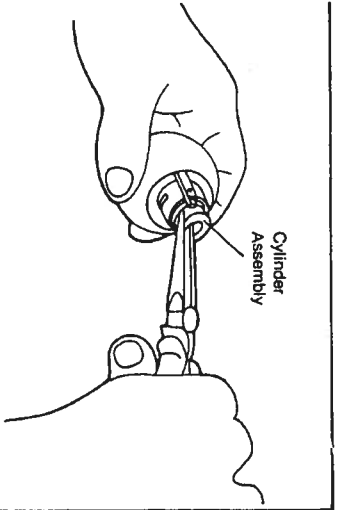
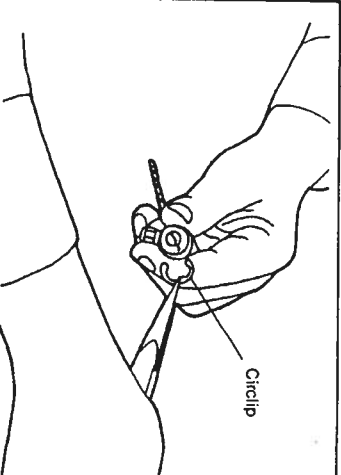

LOCKSET DISASSEMBLY, REKEYING, ASSEMBLY

LOCKSET DISASSEMBLY, REKEYING, ASSEMBLY

13. Turn key 45°-90° left or right.

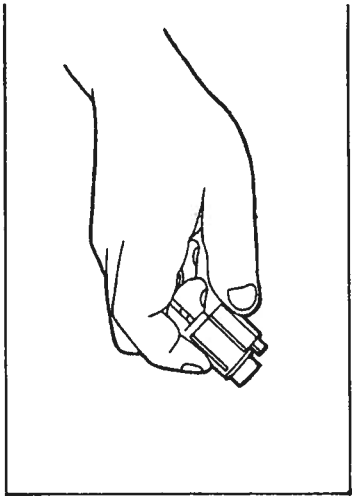

15. Pull out key and remove bottom pins out of pin holes.

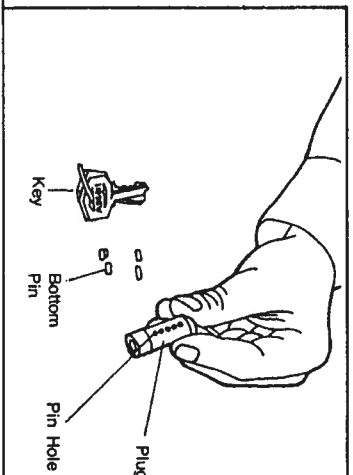

14. Use plug follower to push plug out of cylinder shell. (Note: 2 slots on plug follower head should be horizontal before you insert the follower.)

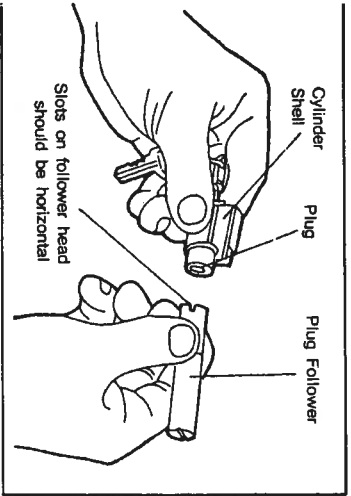

16. Insert new key. For example the new key number stamped on key bow is 22561

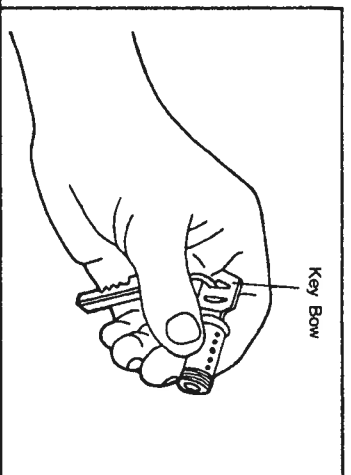

(Note: Do not pull out plug follower from cylinder shell or top pins and springs will come out from shell.)

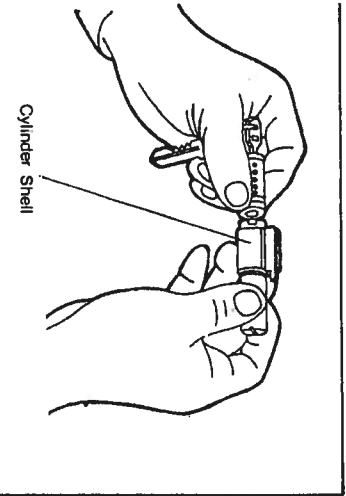

17. Pick a bottom pin #2 from keying kit box and load in 1st hole next to key head, load a bottom pin #2 in 2nd hole, bottom pin #5 in 3rd hole, bottom pin #6 in 4th hole and bottom pin #1 in 5th hole.

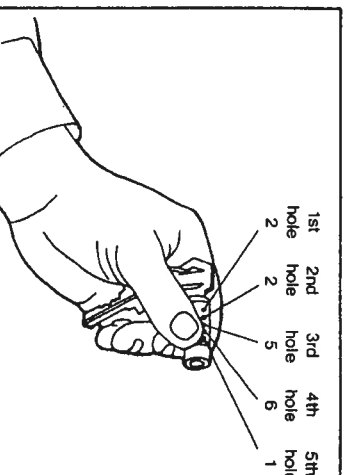

**LOCKSET DISASSEMBLY,
REKEYING, ASSEMBLY**

**LOCKSET DISASSEMBLY,
REKEYING, ASSEMBLY**

18. Make sure all pins are flush against surface of plug with key inserted; file off any excess length of pins as needed; rotate plug with the help of the key when filing so that the pin top conforms with the contour of the plug.

21. Load circlip.

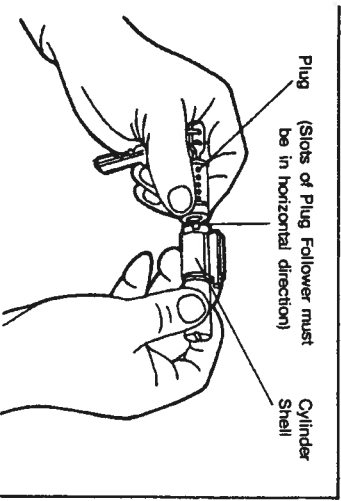

19. Turn key 45°-90°, push plug into cylinder shell.

22. Operate key to check if cylinder functions properly.

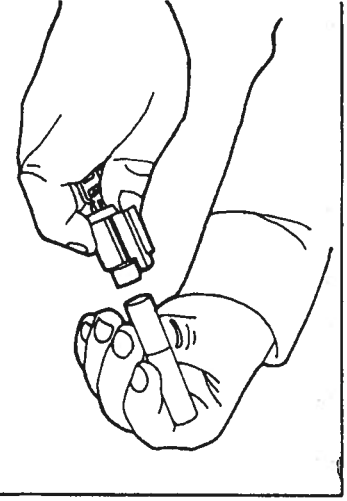

20. Push out follower.

23. Fit plug end cap, make sure dimple on cap is aimed at keyway groove.

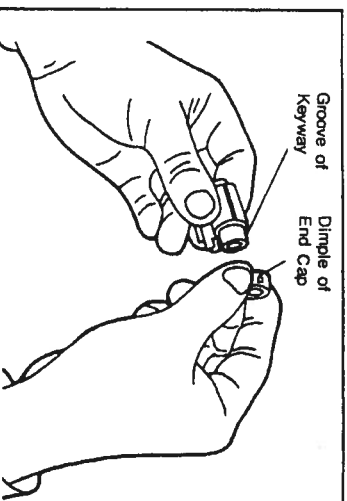
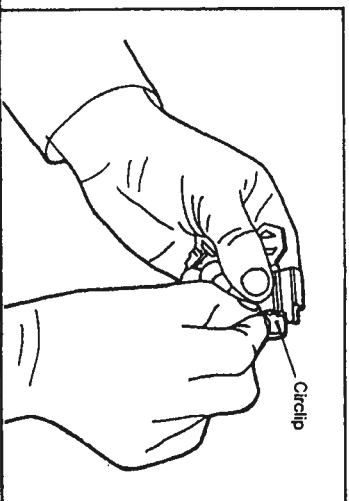

LOCKSET DISASSEMBLY, REKEYING, ASSEMBLY

LOCKSET DISASSEMBLY, REKEYING, ASSEMBLY

24. Push cylinder assembly into knob (use long nose pliers to hold).

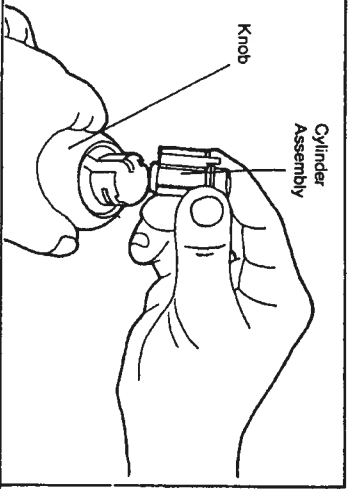

27. Rotate spanner tool to tighten rear cap.

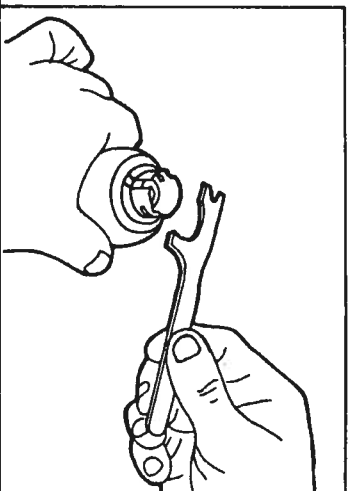

25. Insert key again and remove pliers.

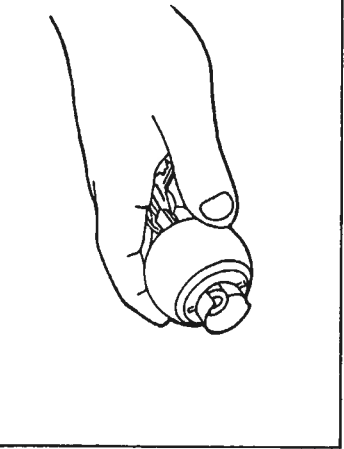

28. Align slot of knob shank and rollback then push outside knob all the way in until knob is retained by knob catch firmly. Rotate knob to check if lock functions properly.

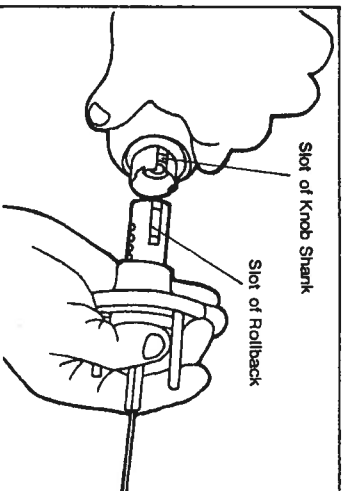

26. Fit rear cap by pushing it onto knob shank.

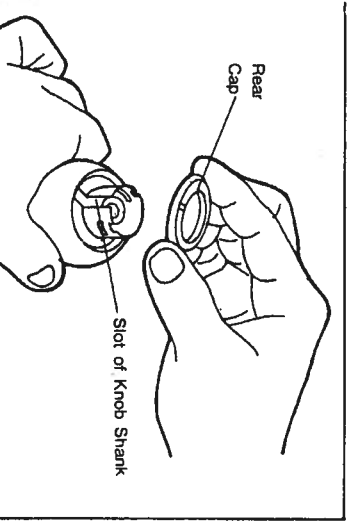

Note: Dimple must be aligned with the slot of the knob shank before sliding the rear cap on the shank.

Turn knob to check if lock functions properly

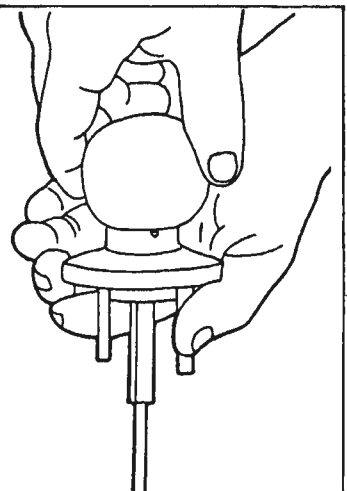

LOCKSET DISASSEMBLY, REKEYING, ASSEMBLY

LOCKSET DISASSEMBLY, REKEYING, ASSEMBLY

3.2. cylindrical Look

Keying

1. Insert key into the plug and turn key to unlock the lock. Turn outside knob clockwise about 30° until the knob catch aligns (is visible) under the catch hole.

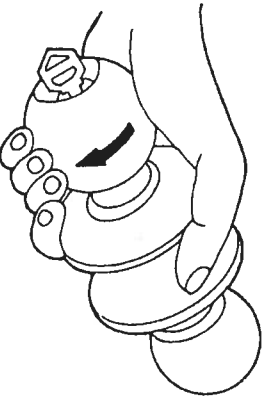

3.3. Deadbolt Look

Keying

1. Insert the key.

Note: Regardless of zinc-diecasted or solid brass cylinder housing, the procedure to rekey a deadlock is the same.

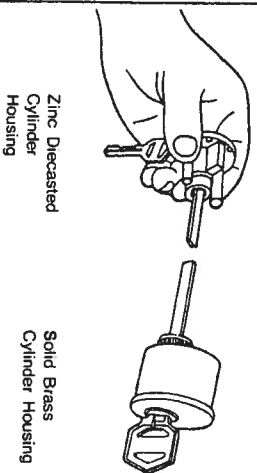

2. With the other hand, turn the key counterclockwise 45°. Use the knob catch tool to depress knob catch and pull to remove outside knob.

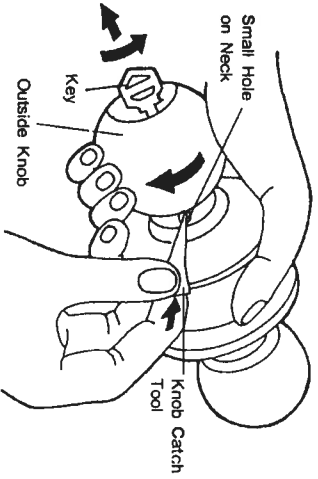

2. Disassemble deadbolt lock, remove cylinder from collar; rotate locking nut tool counterclockwise to loosen locking nut.

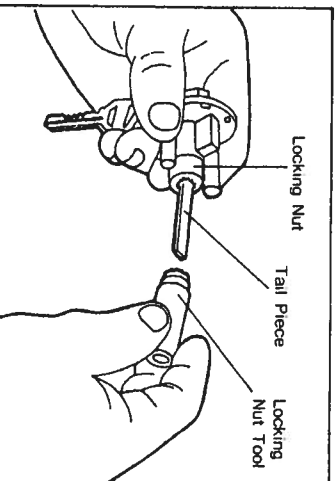

3. Follow the step as described in TUBULAR LOCK KEYING to remove plug for rekeying. Section 3.1, pts 5-28.

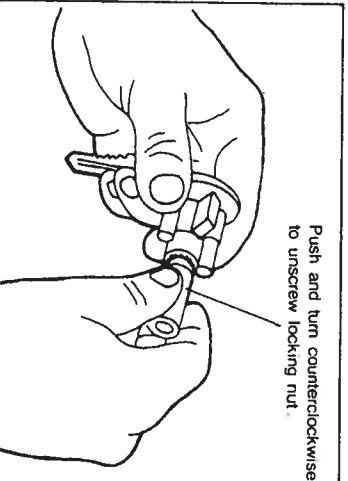

LOCKSET DISASSEMBLY, REKEYING, ASSEMBLY

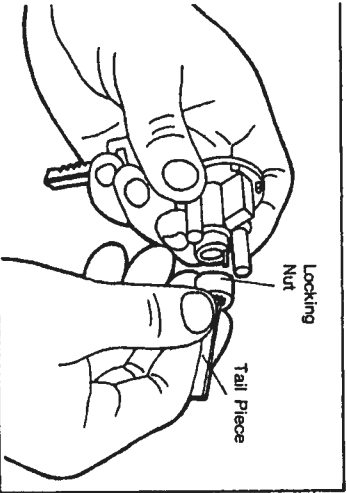

3. Remove locking nut and tail piece.

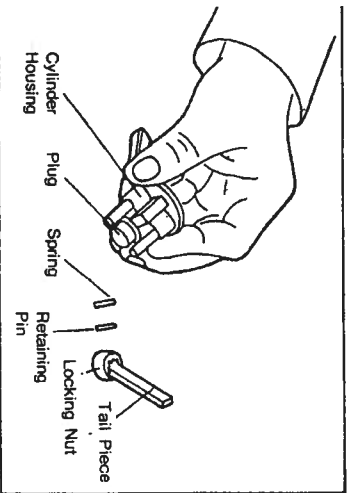

4. Remove retaining pin and spring.

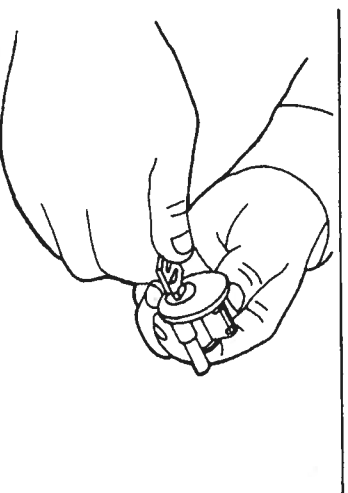

5. Turn key 45°-90°

LOCKSET DISASSEMBLY, REKEYING, ASSEMBLY

6. Insert plug follower to push plug out of cylinder housing. (Note: 2 slots of follower should be horizontal before you insert follower into housing.)

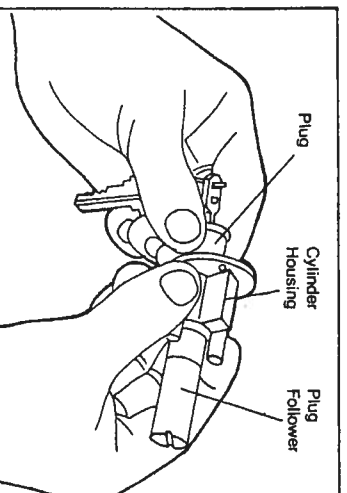

Keep plug follower in cylinder housing, otherwise the top pins and springs will fall out.

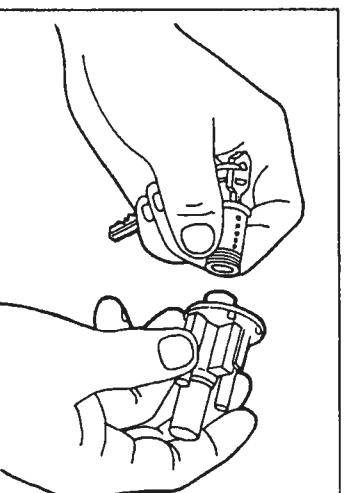

7. Pull out key and remove bottom pins out of pin holes.

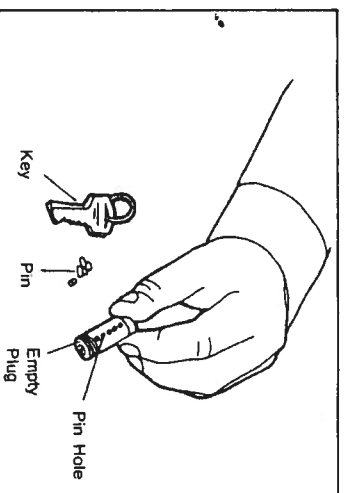

LOCKSET DISASSEMBLY, REKEYING, ASSEMBLY

LOCKSET DISASSEMBLY, REKEYING, ASSEMBLY

Key number is stamped
on key bow

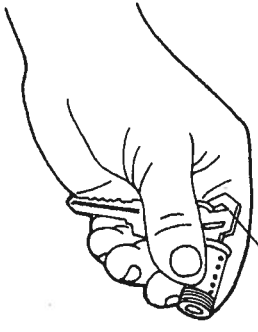

8. Insert new key.

With the pins in place and key in
plug put plug back into cylinder
housing. Push out plug follower
with the plug.

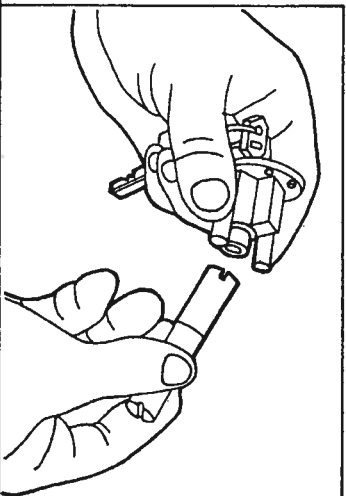

9. Follow the same procedures as
described in Tubular lock to
load bottom pins in plug
according to key number
stamped on key bow. Section
3.1, pgs 16-18.

Try new key to see if it works
smoothly.

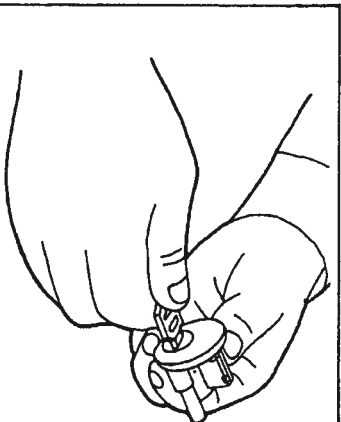

10. Rotate plug 45°-90°, push
plug into cylinder housing.

11. Load spring.

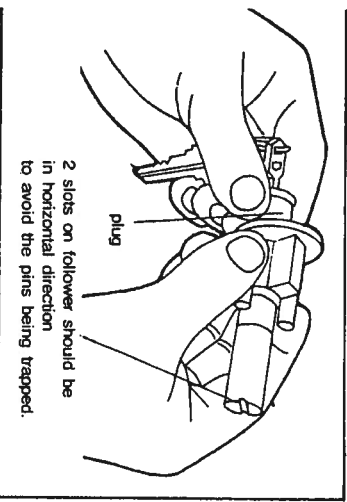

2 slots on follower should be
in horizontal direction
to avoid the pins being trapped.

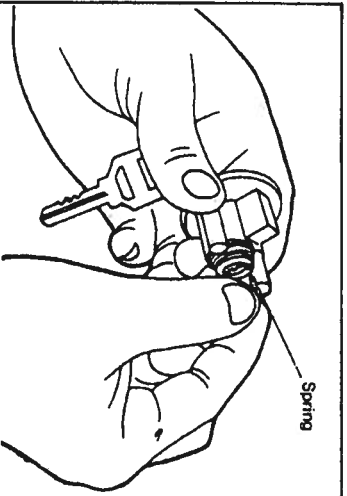

LOCKSET DISASSEMBLY, REKEYING, ASSEMBLY

PRINCIPLE OF PIN TUMBLER MECHANISM

12. Load retaining pin.

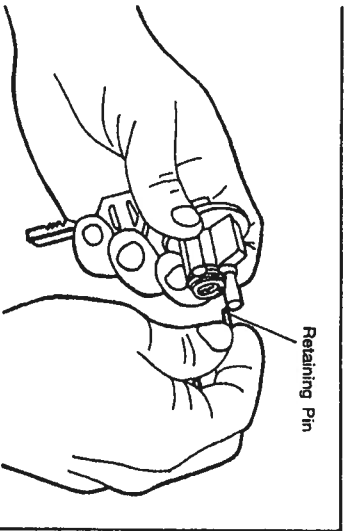

Retaining Pin

13. Fit locking nut with tail piece.

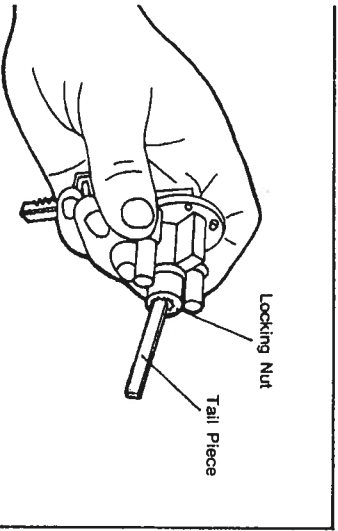

Locking Nut

Tail Piece

14. Tighten locking nut with tool.

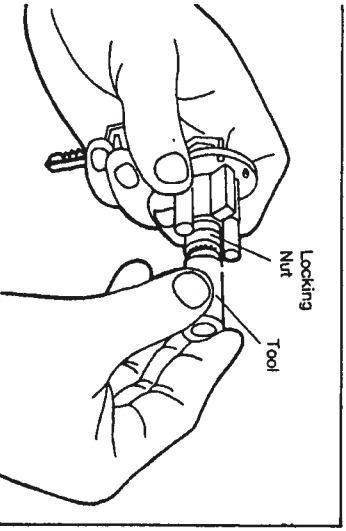

Locking Nut

Tool

The construction of pin tumbler locking mechanism is shown as illustrated,

4.1 Regualr lock—one pin break line:

4.1.1 Locking

With the key removed, top pins are pushed down by springs and held in locking position across pin break line of plug and cylinder shell.

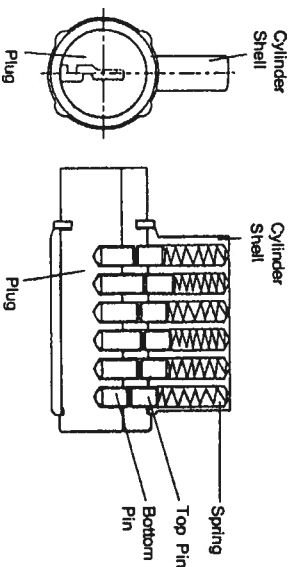

4.1.2 Unlocking

With the correct key inserted into plug, the key will push up bottom pins to the same level at the surface of plug and creates a pin break line. This will allow the key to turn plug and open the lock.

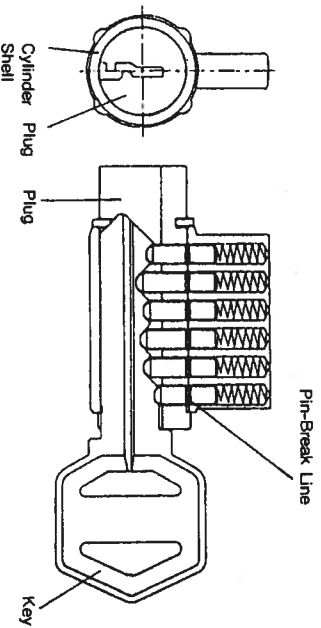

PRINCIPLE OF PIN TUMBLER MECHANISM

4.2 Master keyed lock—2 pin break lines:

In master keyed pin tumbler lock, the middle pins are used so that 2 pin break lines are created. This allows individual key to open the cylinder through a pin break line and also allows the master key to open same cylinder through another pin break line.

4.2.1 Locking

With the key removed, the top pins and middle pins are pushed down by springs and held in locking position across pin break line of plug and cylinder shell.

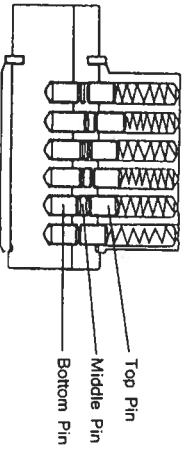

PRINCIPLE OF PIN TUMBLER MECHANISM

4.2.2.2. Master key unlocking:

With the master key inserted, the key will push up bottom pins or middle pins to the same level at the surface of plug and creates another pin break line. This will allow master key to turn plug and open the lock.

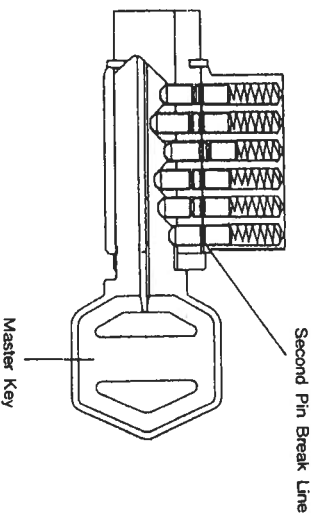

4.2.2 Unlocking

4.2.2.1 Individual Key unlocking:

With individual key inserted, the key will push up bottom pins or middle pins to the same level at the surface of plug and creates a pin break line. This will allow the individual key to turn plug and open the lock.

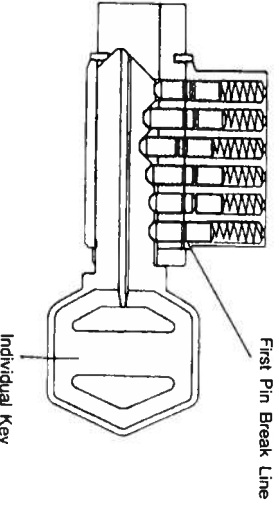

KEYING DEVICE

5.1 Keyed Different (KD):

The key to any individual lock will operate that lock only and no other lock in the group.

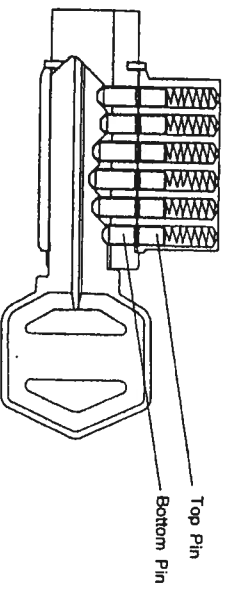

To rekey a KD lock, just follow the procedures shown in TUBULAR LOCK KEYING or DEADLOCK KEYING.

- Remove plug.
- Insert new key and fill in bottom pins according to new key number.
- Assemble plug with cylinder.

5.2 Master Keyed (MK):

Each lock in the group is keyed different. A master key opens all locks in that group.

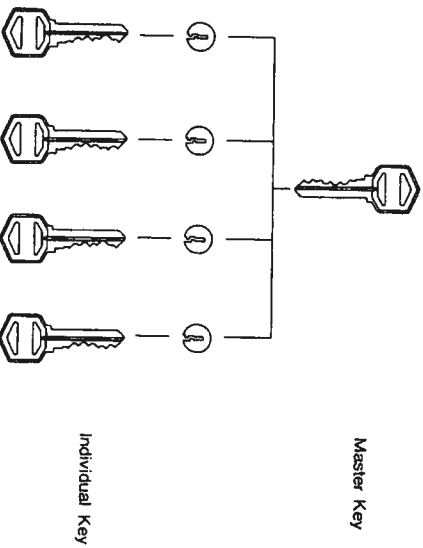

KEYING DEVICE

For example, in a hotel, each guestroom lock has an individual key to open it own lock. The individual key for this door can't open the lock on other doors. Hotel may have a key called master key can open all locks on the same floor. Then all locks can be opened by same master key are called master keyed under same group.

To rekey a lock master keyed, please follow the procedures shown below,

- Set up a mater key number and a group of individual key numbers according to project required.

- For example, the master key number is 17225 and individual key number is 64255.

1	7	2	2	5	Master key number
6	4	2	5	5	Individual key number

- Decide the bottom pin number by choosing the smaller number between master key and individual key.

1	7	2	2	5	Master key number
6	4	2	5	5	Individual key number
1	4	2	2	5	Bottom pin number

5 is the smaller number of 5 and 5
 2 is the smaller number of 2 and 5
 2 is the smaller number of 2 and 2
 4 is the smaller number of 7 and 4
 1 is the smaller number of 1 and 6

- Decide the middle pin number by finding the difference between master key number and individual key number.

1	7	2	2	5	Master key number
6	4	2	5	5	Individual key number
5	3	0	3	0	Middle pin number

Difference of 2 and 5
 Difference of 7 and 4
 Difference of 1 and 6

KEYING DEVICE

- (5) Now you have 4 numbers.
- | | | | | | |
|---|---|---|---|---|--------------------------|
| 1 | 7 | 2 | 2 | 5 | Master key number |
| 6 | 4 | 2 | 5 | 5 | Individual key number |
| 1 | 4 | 2 | 2 | 5 | Bottom pin number |
| 5 | 3 | 0 | 3 | 0 | Master middle pin number |
- (6) Remove plug out of cylinder shell according to procedures shown in TUBULAR LOCK KEYING or DEADLOCK KEYING. Now you have empty plug in before you.
- (7) Load the bottom pins #14225 in empty plug.
- (8) Load master middle pins #5 in 1st hole, master middle pin #3 in 2nd hole and master middle pin #3 in 4th hole.(NOTE: Be sure to pick the right pins-master middle pins. Do not pick the bottom pins. Middle pin is different from bottom pin.) No need to load master middle pin if the number is 0.
- (9) Assemble the plug into cylinder shell according to procedures shown in TUBULAR LOCK KEYING or DEADLOCK KEYING.
- (10) Operate individual key #64255 and master key #17225 to check if both keys can open the lock. If yes, the lock is master keyed.

5.3 Construction Keyed (CK):

Construction Keyed is used where it is necessary for contractor to gain entry by operating builder's key during the construction of a building. Homeowner's key, once operated, shuts out builder's key automatically. To set up a construction keyed system, you need to place a special order for the following parts,

a. Plug drilled with construction holes

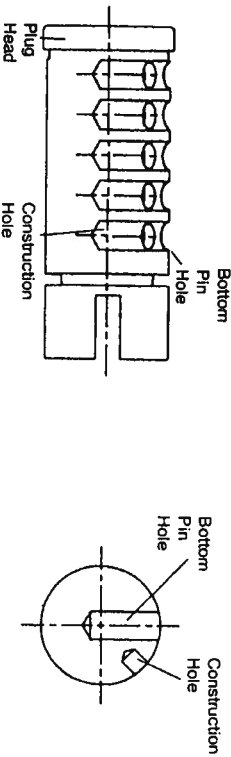

5 construction holes are drilled along bottom pin holes 45° viewed from plug head.

30

KEYING DEVICE

- b. Construction ball
- Construction ball is a small steel ball diameter 2.4mm. The bottom pin has 8 sizes from #1 (4.1mm) to #8 (7.6mm), with each size the difference is 0.5mm. Hence, a construction ball diameter 2.4mm is equal to bottom pin size 5 number difference. (0.5mmX5=2.5mm)
- c. Builder's key & Homeowner's key
- Builder's key is the same as homeowner's key except one of the key cuts is 2.5mm deeper (bottom pin size 5 number difference) than homeowner's key. (NOTE:Builder's key may become a master key, with key number completely not the same as homeowner's key, in construction master keyed system. Please refer to master construction keyed.)

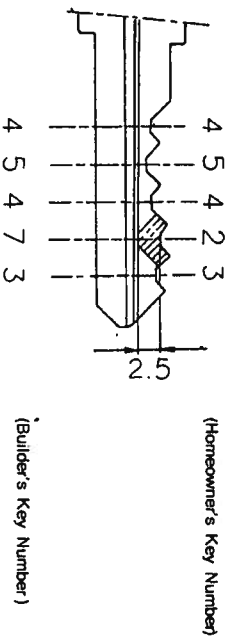

- d. Builder's key tag
- This is a tag to be hung together with builder's key. It is printed on tag.

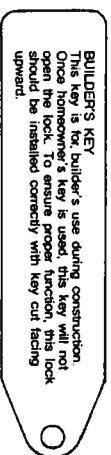

- e. Homeowner's key tag
- This is a tag to be hung together with homeowner's key. A warning sentence is printed on tag.

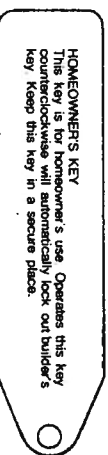

- To rekey a lock to be construction keyed, please follow the procedure shown below,
- (1) Remove plug as described in TUBULAR LOCK KEYING or DEADLOCK KEYING.

31

KEYING DEVICE

KEYING DEVICE

- (2) Set up builder's key number and homeowner's key number. For example, the builder's key number is assigned #45473 and homeowner's key number #45423. (NOTE: One of builder's key cut must be larger than homeowner's key by 5.)
- (3) Insert homeowner's key into plug drilled with construction holes.

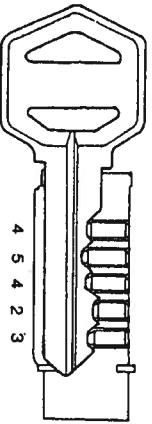

Homeowner's Key

- (4) Load bottom pin #45423 into bottom pin holes. Make sure all pins are flush against plug surface.

- (5) Find out the difference of builder's key number #45473 and homeowner's key number #45423
- | | | | | | |
|----------|----------|----------|----------|----------|-----------------------------------|
| 1st Hole | 2nd Hole | 3rd Hole | 4th Hole | 5th Hole | |
| 4 | 5 | 4 | 7. | 3 | Builder's key number |
| 4 | 5 | 4 | 2 | 3 | Homeowner's key number |
| | | | 5 | | Difference of 2 and 7 in 4th hole |

- (6) Pull out homeowner's key. Insert builder's key. Load a construction ball into 4th hole on top of bottom pin #2.

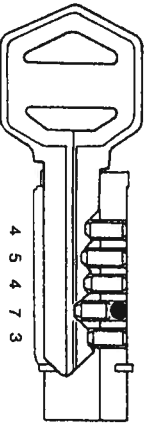

Builder's Key

- (7) Make sure all bottom pins and construction ball are flush against surface of plug.
- (8) Reassemble plug with cylinder shell and then reassemble the whole lock according to TUBULAR LOCK KEYING or DEADLOCK KEYING.
- (9) Hang builder's key tag together with builder's key. Also hang homeowner's key tag together with homeowner's key.

A Construction keyed lock has following features.

- Operate builder's key will open the lock. You may give builder's key to contractor who needs to enter into house during construction.
- Insert homeowner's key, turn clockwise within a limit of 270°, you will open the lock without changing the keying system. (Reason: Construction ball is still remained in pin hole inside plug.)
- Insert homeowner's key, turn counterclockwise 45° or clockwise 270°, the construction ball will be pushed up into top pin hole inside cylinder shell.

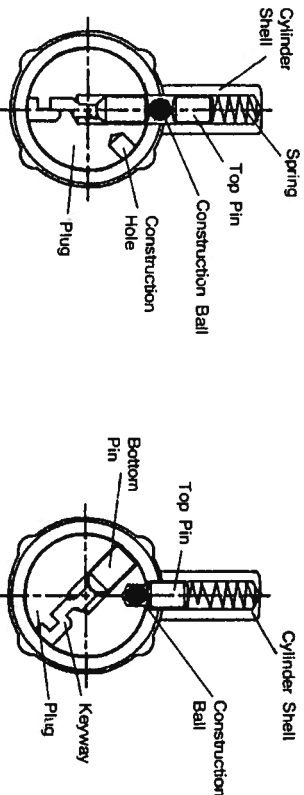

Once you turn homeowner's key any further, construction ball will fall into construction hole on plug. The keying system is now changed and builder's key no longer can open the lock. Hence, do not operate homeowner's key counterclockwise over 45° during construction. Once you did, you will shut out builder's key automatically.

5.4 Master Construction Keyed (MCK) :

In a master construction keyed (MCK) group, builder's key can open all individual locks just like a master key during construction. Homeowner's key just like individual key, once operated, will shut out builder's key (master key) automatically.

For example, there are 50 houses in a construction project. You need to have one builder's key, not 50 builder's key, to open all 50 locks. This builder's key, just like a master key, can open all 50 locks during construction. After construction is completed, homeowner's key, once operated, will shut out builder's key. Then you need to rekey all 50 locks master construction keyed (MCK). The procedure is,

KEYING DEVICE

- (1) Remove plug out of cylinder shell.
- (2) Set up a builder's key number and a group of homeowner's key numbers depend on the number of locks to be master construction keyed.
- (3) For example, builder's key number is designated #17225 and homeowner's key number is #64255, (NOTE: There must be a key number difference between builder's key number and homeowner's key number of just 5. In this case, the 1st hole difference between 1 and 6 is 5. Construction ball must be located at 1st hole
- (4) Use special plug drilled with construction hole.
- (5) List up builder's key number and homeowner's key number to find out bottom pin number, middle pin number and the hole construction ball to be located.

1st hole	2nd hole	3rd hole	4th hole	5th hole
6	4	2	5	5
1	7	2	2	5
1	4	2	2	5
5	3	0	3	0

Builder's key number (master key)
Homeowner's key number
(individual key)
Bottom pin number
(smaller number between builder's key number and homeowner's key number)
Middle pin number
(NOTE: The 1st hole is designated for location of construction ball. Hence, #5 is for construction ball, not middle pin #5.)
- (6) Load bottom pin #14225
- (7) Load 1st hole a construction ball, 2nd hole a middle pin #3 and 4th hole a middle pin #3.
- (8) Reassemble plug with cylinder shell, and also the whole lock as described in TUBULAR LOCK KEYING or DEADLOCK KEYING.
- (9) Operate builder's key and homeowner's key to check if both key can open the locks. If yes, your lock is now master construction keyed.
(NOTE: Do not turn homeowner's key over 270° clockwise or 45° counter-clockwise.)

In short, master construction keyed (MCK) is a combination of MK and CK. You need to order the parts such as plug drilled with construction hole, builder's key, homeowner's key, construction ball and tags before you proceed a master construction keyed.

KEYING DEVICE

5.5 Keyed Alike (KA):

- Keyed alike locks are all built to one key which operates all locks in the system. It may be KA2, KA3, KA4 etc.
- To rekey 2 locks or more keyed alike, just follow the procedure shown below,
- (1) Remove plug out of cylinder shell.
 - (2) Insert the same key, for example #37561, into plug of locks which you need to rekey it to be keyed alike.
 - (3) Fill the same bottom pin #37561 in the plug of each locks. Now all locks, may be 2, 3, 4 or more, are keyed same key number #37561. These locks are keyed alike. You may open all locks by operating same key.
 - (4) Reassemble plug with cylinder shell, then whole lock, as described in TUBULAR LOCK KEYING or DEADLOCK KEYING.